

SeekTech[®] ST[™] Transmitter

ST-33Q+



⚠ WARNING!

Read this Operator's Manual carefully before using this tool. Failure to understand and follow the contents of this manual may result in electrical shock, fire and/or serious injury.

For support and additional information about using your ST-33Q+ go to support.seesnake.com/st-33q+ or scan this QR code.



Table of Contents

Introduction

Regulatory Statements	4
Safety Symbols.....	4

General Safety Rules

Work Area Safety.....	5
Electrical Safety.....	5
Personal Safety	5
Equipment Use and Care	6
Battery Use and Care	6

Specific Safety Information

ST-33Q+ Safety	7
----------------------	---

Product Overview

Description	7
Specifications	8
Standard Equipment.....	8
Components	8
Keypad Legend	9
Screen Icon Legend	9

Pre-Operation Inspection

Work Area and Equipment Set Up

Kick Stand Positioning.....	11
Cable Lead Clips	11
High Voltage Indicator.....	11
High Temperature Warning.....	11
Powering the ST-33Q+.....	12

Operating Instructions

Bluetooth Connection	13
Locate.....	18
Direct Connect Mode.....	19
High Output Mode	20
Inductive Clamp Mode.....	20
Inductive Mode	21
Air-Coupling	23
Helpful Hints	24

Customizing Settings

Auto-shutdown Setting..... 24
 Frequencies 24
 Custom Frequencies..... 25
 Odometer..... 26
 Reset to Factory Default 27

Software

Updating ST-33Q+ Software 27

Maintenance

Cleaning 28
 Accessories 28
 Transport and Storage 28
 Service and Repair 29
 Disposal..... 29
 Battery Disposal 30
 Troubleshooting 31
 Appendix: Frequencies Used by Other Manufacturers

Introduction

The warnings, cautions, and instructions discussed in this operator's manual cannot cover all possible conditions and situations which may occur. It must be understood by the operator that common sense and caution are factors that cannot be built into this product, but must be supplied by the operator.

Regulatory Statements

CE The EC Declaration of Conformity (890-011-320.10) will accompany this manual as a separate booklet when required.

FCC This device complies with Part 15 of FCC rules. Operation is subject to the following two conditions: (1) This device may not cause harmful interference, and (2) this device must accept any interference received, including interference that may cause undesired operation.

Safety Symbols

In this operator's manual and on the product, safety symbols and signal words are used to communicate important safety information. This section is provided to improve understanding of these signal words and symbols.



This is the safety alert symbol. It is used to alert you to potential personal injury hazards. Obey all safety messages that follow this symbol to avoid possible injury or death.

DANGER

DANGER indicates a hazardous situation which, if not avoided, will result in death or serious injury.

WARNING

WARNING indicates a hazardous situation which, if not avoided, could result in death or serious injury.

CAUTION

CAUTION indicates a hazardous situation which, if not avoided, could result in minor or moderate injury.

NOTICE NOTICE indicates information that relates to the protection of property.



This symbol means read the operator's manual carefully before using the equipment. The operator's manual contains important information on the safe and proper operation of the equipment.



This symbol means always wear safety glasses with side shields or goggles when handling or using this equipment to reduce the risk of eye injury.



This symbol indicates the risk of electrical shock.

General Safety Rules

⚠ WARNING

Read all safety warnings and instructions. Failure to follow the warnings and instructions may result in electric shock, fire, and/or serious injury.

SAVE THESE INSTRUCTIONS!

Work Area Safety

- **Keep your work area clean and well lit.** Cluttered or dark areas invite accidents.
- **Do not operate equipment in explosive atmospheres, such as in the presence of flammable liquids, gases, or dust.** Equipment can create sparks which may ignite the dust or fumes.
- **Keep children and bystanders away while operating equipment.** Distractions can cause you to lose control.

Electrical Safety

- **Avoid body contact with earthed or grounded surfaces such as pipes, radiators, ranges, and refrigerators.** There is an increased risk of electrical shock if your body is earthed or grounded.
- **An improperly grounded electrical outlet can cause electrical shock and/or severely damage equipment.** Always check work area for a properly grounded electrical outlet. Presence of a three-prong or GFCI outlet does not ensure that the outlet is properly grounded. If in doubt, have the outlet inspected by a licensed electrician.
- **Do not expose equipment to rain or wet conditions.** Water entering equipment will increase the risk of electrical shock.
- **Do not abuse the cord.** Never use the cord for carrying, pulling, or unplugging the power tool. Keep cord away from heat, oil, sharp edges, and moving parts. Damaged or entangled cords increase the risk of electric shock.
- **If operating equipment in a damp location is unavoidable, use a ground fault circuit interrupter (GFCI) protected supply.** Use of a GFCI reduces the risk of electric shock.
- **Keep all electrical connections dry and off the ground.** Do not touch equipment or plugs with wet hands to reduce the risk of electrical shock.

Personal Safety

- **Stay alert, watch what you are doing, and use common sense when operating equipment.** Do not use equipment while you are tired or under the influence of drugs, alcohol, or medication. A moment of inattention while operating equipment may result in serious personal injury.
- **Use personal protective equipment.** The appropriate use of protective equipment such as safety glasses, a dust mask, non-skid safety shoes, a hard hat, high visibility clothing, and hearing protection will reduce personal injuries.
- **Do not overreach.** Keep proper footing and balance at all times. This enables better control of the equipment in unexpected situations.
- **Dress properly.** Do not wear loose clothing or jewelry. Keep your hair, clothing, and gloves away from moving parts. Loose clothes, jewelry, and long hair can be caught in moving parts.

Equipment Use and Care

- **Do not force equipment.** Use the correct equipment for your application. The correct equipment will do the job better and safer at the rate for which it is designed.
- **Do not use equipment if the power switch does not turn it on and off.** Any equipment that cannot be controlled with the power switch is dangerous and must be repaired.
- **Disconnect the plug from the power source and/or the battery pack from the equipment before making adjustments, changing accessories, or storing.** Preventive safety measures reduce the risk of injury.
- **Store idle equipment out of the reach of children and do not allow persons unfamiliar with the equipment or these instructions to operate the equipment.** Equipment can be dangerous in the hands of untrained users.
- **Maintain equipment.** Check for misalignment or binding of moving parts, missing parts, breakage of parts, and any other condition that may affect the equipment's operation. If damaged, have the equipment repaired before use. Many accidents are caused by poorly maintained equipment.
- **Use the equipment and accessories in accordance with these instructions; taking into account the working conditions and the work to be performed.** Use of the equipment for operations different from those intended could result in a hazardous situation.
- **Use only accessories that are recommended by the manufacturer for your equipment.** Accessories that may be suitable for one piece of equipment may become hazardous when used with other equipment.
- **Keep handles dry, clean, and free from oil and grease.** This allows for better control of the equipment.

Battery Use and Care

- **Use equipment only with specifically designated battery packs.** Use of any other battery packs may create a risk of injury and fire.
- **Recharge only with the charger specified by the manufacturer.** A charger suitable for one type of battery pack may create a risk of fire when used with another battery pack.
- **Do not probe battery with conductive objects.** Shorting of battery terminals may cause sparks, burns, or electrical shock. When the battery pack is not in use, keep it away from other metal objects, like paper clips, coins, keys, nails, screws or other small metal objects that can make a connection from one terminal to another. Shorting the battery terminals together may cause burns or a fire.
- **Under abusive conditions, liquid may eject from battery; avoid contact.** If contact occurs, flush with water. If liquid contacts eyes, seek medical help. Liquid ejected from the battery may cause irritation or burns.
- **Do not cover charger while in use.** Proper ventilation is required for correct operation. Covering charger in use could result in fire.
- **Use and store batteries and chargers in dry, appropriate temperature areas.** Extreme temperatures and moisture can damage batteries and result in leakage, electrical shock, fire or burns.
- **Properly dispose of batteries.** Exposure to high temperatures can cause the batteries to explode; do not dispose of in a fire. Some countries have regulations concerning battery disposal. Follow all applicable regulations.
- **See the Battery and Battery Charger Operator's Manual for additional information.**

Specific Safety Information

⚠ WARNING

This section contains important safety information that is specific to the ST-33Q+. Read these precautions carefully before using the ST-33Q+ to reduce the risk of electrical shock, fire, or other serious injury.

SAVE ALL WARNINGS AND INSTRUCTIONS FOR FUTURE REFERENCE!

ST-33Q+ Safety

- **Read and understand this operator's manual, and the instructions for any other equipment in use and all warnings before operating the ST-33Q+.** Failure to follow all instructions and warnings may result in property damage and/or serious personal injury. Keep this manual with the equipment for future use.
- **Operating the equipment while in water increases the risk of electrical shock.** Do not operate the ST-33Q+ if the operator or equipment are standing in water.
- **The ST-33Q+ is not designed to provide high voltage protection and isolation.** Do not use where a danger of high voltage contact is present.
- **Always attach leads before turning the ST-33Q+ on and always power off the ST-33Q+ before disconnecting the leads to reduce the risk of electrical shock.**
- **Follow local guidelines and call before digging.** Locating equipment uses electromagnetic fields that can be distorted and interfered with. More than one utility may be present in a given area. Follow local guidelines and service procedures. Confirm location of utilities before digging.

Product Overview

Description

The ST-33Q+ is a powerful, multi-frequency transmitter which can be used in conjunction with a RIDGID-SeekTech receiver to find buried conductors such as pipes, cables, and wires. Connect the ST-33Q+ to a RIDGID-SeekTech SR-24 using Bluetooth® to remotely control the transmitter and view changes from the receiver. Cut the time it takes to locate facilities by syncing the ST-33Q+ with the SR-24 and removing the need to walk back and forth between devices.

The ST-33Q+ can apply an active tracing signal to target a conductor using the following three modes:

Direct Connect — The leads on the ST-33Q+ connect directly to the target conductor and a suitable ground.

Inductive Clamp — The optional inductive clamp encircles the target conductor which eliminates metal-to-metal contact.

Inductive — The ST-33Q+ is placed over an in-line conductor. The internal antenna will induce a signal to locate the target conductor.

In addition to a series of default frequencies, the ST-33Q+ can also accept custom frequency settings up to 490 kHz.

Specifications	
Weight without batteries	5 kg [11 lb]
Dimensions	
Depth	202 mm [8 in]
Width	432 mm [17 in]
Height	421 mm [16.6 in]
Coil cable length	0.4 m – 7.6 m [1.4 ft – 25 ft]
Output power	
18 V Li-Ion battery/ External power adapter	10 W
6 D-cell batteries	5 W
Power settings	
Internal batteries	25 mA – 400 mA
18V Li-Ion battery/ External power adapter	≤ 1,000 mA
Default frequencies	128 Hz, 1 kHz, 8 kHz, 33 kHz, 93 kHz, 262 kHz
Bluetooth	
Type	Class 1
Profile	RFCOMM
Transmit power	19 dBm
Receiver sensitivity	-92 dBm
Operating range	Up to 800 m [2,725 ft]
Ingress protection	IP 54
Storage temperature	-10°C – 70°C [14°F – 158°F]







*Effective distance may vary.













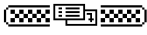
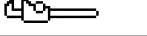





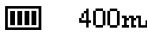

Standard Equipment

- ST-33Q+
- Operator's manual

Components

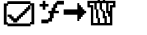

Keypad Legend		
Key	Name	Function
	Inductive Mode Key	Toggle between Inductive Mode and Direct Connect Mode.
	Up Arrow Key	Move up or increase.
	Select Key	Activate a frequency or select highlighted menu choices.
	Down Arrow Key	Move down or decrease.
	Menu Key	Access the Main Menu. Moves back one level within submenus.
	Frequency Key/Left Arrow Key	Step through the list of active frequencies in the current mode. Long press displays a scrollable list of frequencies. Also acts as the Left Arrow key within menus.
	Power Key/Right Arrow Key	Power the ST-33Q+ on and off. Also acts as the Right Arrow key within menus.

Screen Icon Legend	
Icon	Definition
	Available Frequencies
	Frequency not available, in use, or locked
	Sub Menus
	Tools Menu
	LCD Screen Brightness Adjustment
	Audio on/off
	Auto Shutdown Setting
	Add Frequencies to Main Menu
	Set Custom Frequencies
	Standard Power Mode for Li-Ion 18 V and 10-28 VDC power adapter
	Default, Low Output Power Mode for NiMH batteries
	High Output Power Mode for NiMH batteries
	Max Power Mode for alkaline D-cell batteries
	Information Screen
	Factory Reset
	Delete Custom Frequencies
	Odometer
	Full Battery
	Partial Battery
	Low Battery
	18 V battery is dead, operating on internal batteries
	The ST-33Q+ is connected to and paired with a Bluetooth enabled device

Pre-Operation Inspection

⚠ WARNING



Before each use, inspect the ST-33Q+ and correct any problems to reduce the risk of serious injury from electrical shock, fire, and other causes and to prevent damage to the ST-33Q+.

1. Confirm that the power is off, that any external power and cords are disconnected, and that all batteries are removed. Inspect the cords, cables, and connectors for damage or modification.
2. Clean any dirt, oil, or other contamination from the ST-33Q+ to aid in inspection and to prevent the unit from slipping from your grip during transport or use.
3. Inspect the ST-33Q+ for any broken, worn, missing, misaligned or binding parts, or any other condition which might prevent safe, normal operation.
4. Inspect any other equipment being used according to its instructions to make sure it is in good, usable condition.
5. If any problems are found, do not use the equipment until the problems are corrected.

Work Area and Equipment Set Up

⚠ WARNING



Set up the ST-33Q+ and work area in accordance with these procedures to reduce the risk of serious injury from electrical shock, fire, and other causes and to prevent damage to the ST-33Q+.

1. Check work area for the following:
 - Adequate lighting.
 - Flammable liquids, vapors, or dust that may ignite. If present, do not work in area until sources have been identified and corrected. Equipment can create sparks which may ignite the dust or fumes.
 - Clear, level, stable dry place for operator to work. Do not use the equipment while standing in water.
 - Clear path to electrical outlet that does not contain any potential sources of damage for the power cord when using external power.
2. Assess the target line to determine the best way to apply the signal. The line must be metal (conductive) in order to have a signal applied to it using the ST-33Q+. If using the transmitter on insulated conductors, ground the target conductor at each end to ensure that the signal will be strong enough to locate.

The ST-33Q+ is not designed to provide high voltage insulation or protection. Do not use where a danger of high voltage contact is present.
3. Determine the correct equipment for the application.
4. Make sure all equipment has been properly inspected.
5. Evaluate the work area and determine if any barriers are needed to keep bystanders away. Bystanders can distract the operator during use. If working near traffic, erect cones or other barriers to alert drivers.

Kick Stand Positioning

The kick stand on the ST-33Q+ gives you control over the angle of the unit. Use the kick stand to improve screen visibility and access to the keypad.

Cable Lead Clips

The ST-33Q+ features cable lead clips that can be attached mechanically or magnetically. Before connecting the leads, use the teeth on the clip to scrape off rust or paint. When the metal is exposed you can either clip onto the target with the teeth or use the magnet to make the connection.

NOTICE The cable lead clips contain strong magnets. Do not place the clips near data storage devices, credit cards, or other magnetically encoded data.



High Voltage Indicator

⚠ WARNING



The ST-33Q+ is designed to withstand up to 240 VAC between the two leads. This protection is not intended to be used continuously and excess current may be forced through the ST-33Q+. To reduce the risk of electrical shock, do not touch the transmitter, cords, or connections during this time. Use high voltage precautions to disconnect the ST-33Q+.

If the ST-33Q+ senses excess current, a warning message appears on the screen, a warning beep sounds, and the High Voltage LED below the keypad is lit.

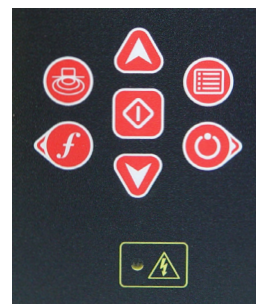

High Temperature Warning

If the internal temperature of the ST-33Q+ reaches 75°C [167°F] an alert displays on the screen and signal output is automatically reduced. If the internal temperature reaches 80°C [176°F], signal output is immediately suspended. Power off the ST-33Q+ to avoid damage and injury and contact a RIDGID Independent Authorized Service Center before using the ST-33Q+ again.

Powering the ST-33Q+

⚠ WARNING

Disconnect external leads from any energized utility before opening the battery compartment. To prevent overheating and leakage, do not mix battery types or used and new batteries. Always remove the batteries before shipping or storing the ST-33Q+.

The ST-33Q+ can be powered by a Li-Ion 18 V rechargeable battery, six D-cell batteries, or an external 10-28 VDC power source.

An 18 V rechargeable battery can be used simultaneously with the internal alkaline or NiMH D-cell batteries. Do not mix battery types or brands, and do not combine new and used batteries.

Li-Ion 18 V Rechargeable Battery

The ST-33Q+ can be powered from one Li-Ion 18 V rechargeable battery as long as the voltage remains above 14.4 V. If the voltage falls below 14.4 V or if the battery dies, the ST-33Q+ will switch to internal batteries and display an alert.



D-Cell Battery Power

New alkaline D-cell batteries, with a load of 100 Ω at a frequency of 8 kHz and a power level of 100 mA, can power the ST-33Q+ for approximately 17.5 hours. Actual operation life varies with battery rating and use.

Install alkaline or NiMH D-cell batteries in the ST-33Q+ by following these steps:

1. Twist battery compartment caps counterclockwise.
2. Insert three batteries into each battery compartment. Ensure the positive end of each battery points outward.
3. Replace the caps and twist clockwise to tighten.

Note: Rechargeable D-cell batteries do not recharge in the ST-33Q+.

External Power

The ST-33Q+ can also be powered by an external 10-28 VDC no less than 35 W.

Read and follow the instructions as specified by the manufacturer of the adapter before using it with the ST-33Q+. To prevent electrical shock and damage, ensure the external power source is fully isolated from the ground and power mains. Do not use a non-isolated power supply with the ST-33Q+.

When a 10-28 VDC power source is connected, use of the alkaline D batteries and the 18 V rechargeable battery is discontinued and the unit draws from the 10-28 VDC power source. The ST-33Q+ automatically powers off when a 10-28 VDC power source is plugged in.

Ensure the adapter cord has a clear, dry path and does not contain any potential source of damage. Use dry hands to plug and unplug the cord.

Operating Instructions

⚠ WARNING



Wear eye protection when appropriate to protect your eyes against dirt and other foreign objects. Follow operating instructions to reduce the risk of injury from electrical shock and other causes.

The default frequencies that come with the ST-33Q+ are:

- 128 Hz
- 1 kHz [1,024 Hz]
- 8 kHz [8,192 Hz]
- 33 kHz [32,768 Hz]
- 93 kHz [93,623 Hz]
- 262 kHz [262,144 Hz]

Exclude default frequencies from the active frequency list and add your own custom frequencies in the Tools Menu. Frequency lists are context sensitive so that each mode can have a separate list of active frequencies. To learn more, see the Customizing section of this Operator's Manual.

Bluetooth Connection

Bluetooth® connectivity with a SeekTech SR-24 receiver or other Bluetooth enabled SeekTech receiver allows users to remotely set frequencies, output power, turn the ST-33Q+ on and off, or know if the ST-33Q+ has turned off unexpectedly.

With Bluetooth® enabled on the ST-33Q+, the SR-24 can be used to view and control the ST-33Q+'s screen, eliminating the need to walk back and forth between your transmitter and the area being traced.



Range



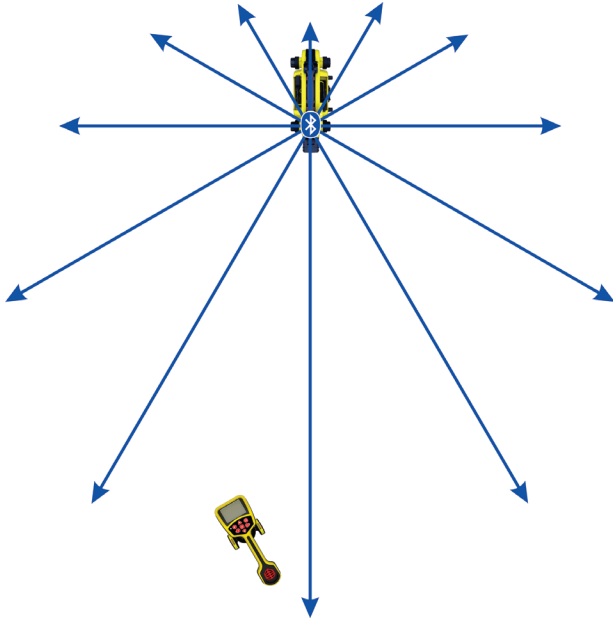





The ST-33Q+ and SR-24 work best when kept within 200 m [656 ft] of each other while connected by Bluetooth. The quality of the connection between devices may be affected by a number of factors including distance between devices and objects in the path between devices. For the best quality connection, maintain a clear line of sight between devices and set the transmitter so its battery faces the receiver. Objects blocking the line of sight between the transmitter and the receiver may significantly reduce the quality of their connection.



Bluetooth Connection

Connecting the Devices

To connect the devices, follow these steps:

4. Power on the receiver and press the Menu key .
5. Press the Down Arrow key  to scroll through the frequencies list. Highlight the Bluetooth icon  and press the Select key .
6. Press the Select key  when the search icon  appears.
7. Press the Down Arrow key  to highlight the transmitter you want to connect to. Press the Select key .

You can identify your transmitter by its name and the last four digits of its serial number. The transmitter does not need to be powered on to be discoverable.

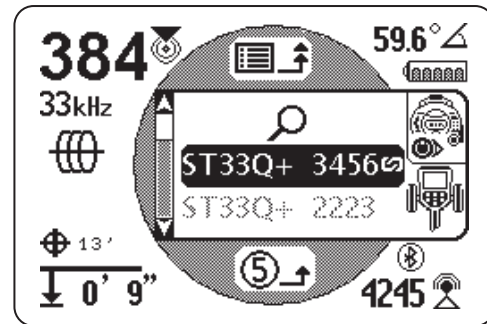

Once a connection is made, the transmitter automatically powers on. When connected, the Bluetooth icon  is visible on both the transmitter's and the receiver's screens. On the transmitter, a chain link image confirms that the two units are connected.







If the receiver has been paired with multiple transmitters, it automatically goes through the list and tries to connect to each one until it is successful.

Note: The receiver can remember up to 16 devices it has been paired with. For more information on connecting to other devices, refer to the SR-24 manual.

Disconnecting the Devices

The two devices remain connected until manually disconnected. To disconnect the devices, follow these steps:

1. Make sure both the transmitter and receiver are powered on. On the receiver, press the Menu key .
2. Press the Down Arrow key  to navigate to and highlight the Bluetooth icon .
3. Press the Select key . The disconnect icon  displays when the devices have successfully disconnected.

On the transmitter, an image of a broken chain link confirms that the two units are disconnected.

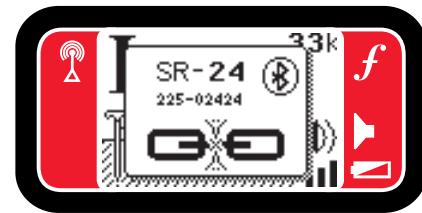

On the receiver, a warning alert displays.

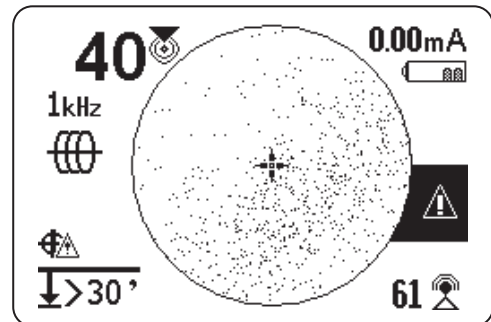

Powering the Transmitter

When the two units are connected with Bluetooth, powering the receiver on or off automatically powers the transmitter on or off.

The receiver alerts you to changes in the transmitter's power status.

	<p>Switching to internal batteries.</p>
	<p>Powered off due to Power key press.</p>
	<p>Powered off due to low battery.</p>



Setting the Frequency

Changing the receiver's frequency automatically updates the transmitter's frequency to match. If the frequency is changed on the transmitter, the receiver automatically updates to match as well.

Transmitter Control Screen

When the devices are connected, you can see the transmitter's screen from the receiver. The transmitter control screen allows you to control the transmitter's frequency mode, choose between direct connect or inductive mode, and adjust output power remotely. You can also remotely power the transmitter on or off and know if the transmitter has powered off unexpectedly.

Any changes made on the transmitter to frequency, direct connect or inductive mode, and output power can be seen on the receiver.

To open the transmitter control screen on the receiver, press the Menu key , then press the Right Arrow key  to toggle in and out of the transmitter's control screen.

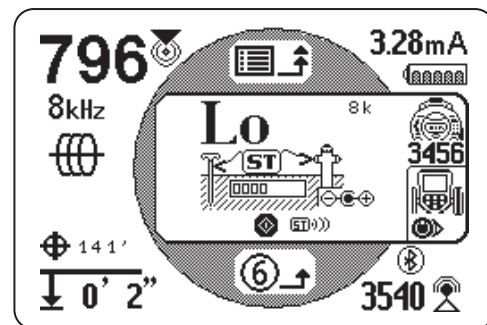

If more than one Bluetooth enabled SeekTech transmitter is present, press the Left Arrow key  to cycle through available transmitters. Press the serial number listed below the transmitter icon to identify the specific transmitter you want to control.

Direct Connect Mode and Inductive Mode

To remotely set the transmitter to direct connect mode or inductive mode using the receiver, open the transmitter control screen. Press the Select key  to toggle between direct connect mode and inductive mode.

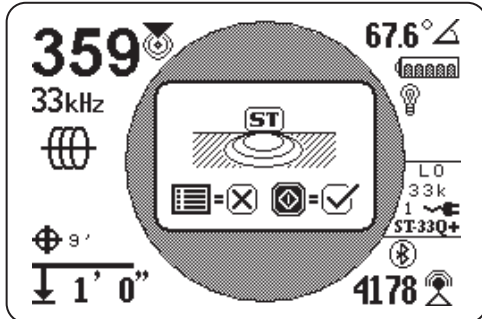



Clamp Mode

The receiver can see the transmitter's clamp mode but cannot turn the transmitter's clamp mode on or off. An inductive clamp must be connected to access clamp mode. Refer to the operator's manual for your transmitter and inductive clamp for more information on using inductive clamp mode.

Output Power

Higher output settings produce a stronger signal for the receiver, but reduces battery life for the transmitter. Only use 1,000 mA High Output Mode if using an 18 V Li-Ion rechargeable battery, external power, or high capacity NiMH D-cell batteries. Do not use the ST-33Q+ in high output mode with standard alkaline batteries.





You can read the transmitter's output power or change it remotely from the receiver. To remotely change the transmitter's output power using the receiver, open the transmitter control screen. Press the receiver's Up and Down Arrow keys   to adjust the output power.

Locate



Note: When the ST-33Q+ is powered on and in Direct Connect Mode, only hold the cable leads by the plastic sheathing. Do not touch the metal scraper tip, teeth, or magnet.

1. With one cable lead attached to the ground stake and the other attached to the target conductor, press the Power key  to power on the ST-33Q+.

Upon start up, the ST-33Q+ measures the current flowing through the target conductor and beeps to indicate output. Faster beeps indicate a higher output current.

2. Select a frequency by pressing the Frequency key  until the desired frequency appears or pressing and holding the Frequency key to show a list of available frequencies. Press the Up and Down Arrow keys   to move through the list. When the desired frequency is highlighted, press the Select key  to activate it.

Note: In addition to the default frequencies, the ST-33Q+ can also accept custom frequency settings up to 490 kHz. See the section on adding custom frequencies in this Operator's Manual for more details.

3. Follow the instructions in the receiver's Operator's Manual to power on and use the receiver. Ensure the frequency on the receiver matches the ST-33Q+. If the receiver signal increases when held near the ST-33Q+, it is correctly picking up the transmitted frequency.
4. Adjust the current as needed during the locate by pressing the Up and Down Arrow keys   on the ST-33Q+. In Direct Connect Mode, the ST-33Q+ increases the current as close to the following levels as possible:
 - 25 mA
 - 50 mA
 - 100 mA (default)
 - 200 mA
 - 400 mA
5. After completing the locate, press the Power key  to power off the ST-33Q+.

Note: To reduce the risk of electrical shock, power off the ST-33Q+ before disconnecting the leads and remove the lead from the target conductor before removing the lead from the ground stake.

Direct Connect Mode

Direct Connect Mode is most commonly used when the target utility is readily accessible. Do not use Direct Connect Mode on energized (live) conductors. The ST-33Q+ is not designed to connect to live conductors.

1. Choose connection locations for the ground stake and the target conductor. Place the ST-33Q+, powered off, on the ground between these two locations.

Note: The ST-33Q+ leads extend up to 7.6 m [25 ft]. The further the leads are extended, the more incidental the signal, and the further the receiver should be used from the transmitter to avoid confusing the signals with the cable leads. If performing a locate near the transmitter, keep the leads as short as possible and store excess lead cable in the side pockets of the ST-33Q+.

2. Insert the ground stake into the earth as far as possible. Wet the earth around the ground stake to improve grounding and to lower the resistance of the ground. With the ST-33Q+ still powered off, attach the lead clip to the ground stake.



Instead of using the provided grounding stake, the lead clip can be attached to other objects such as a shovel blade or a metal rod sunk into the earth. Using larger grounding objects may improve grounding by increasing the surface area in contact with the earth.

Note: Always connect the lead to the ground stake before connecting another lead to the target line to direct any current within the target conductor away from the user.

3. At the target conductor, scrape away any dirt, paint, corrosion, or other coatings and attach the other cable lead clip with either the teeth or the magnet.







Good contact between the cable lead and the target conductor lowers the resistance of the circuit and produces a stronger tracing signal.

Note: Non-conductive pipes, such as those made of clay or plastic, cannot carry a tracing current without a trace wire. Plastic pipes typically have a trace wire installed with the pipe for tracing purposes. Clip the cable lead to the trace wire to enable tracing.

High Output Mode

Higher output settings produce a stronger signal for the receiver, but reduces battery life. Only use 1,000 mA High Output Mode if using an 18 V Li-Ion rechargeable battery, external power, or high capacity NiMH D-cell batteries. Do not use the ST-33Q+ in high output mode with standard alkaline batteries.

Under normal operating conditions, the output in Direct Connect Mode is limited to 400 mA to extend battery life. The current can be adjusted to operate the ST-33Q+ in high output mode by using the Up and Down Arrow keys   to toggle between  400mA and  1000mA.

In Direct Connect Mode the ST-33Q+ displays a current indicator bar. Hollow boxes represent selected output current. Solid boxes represent actual output current levels.

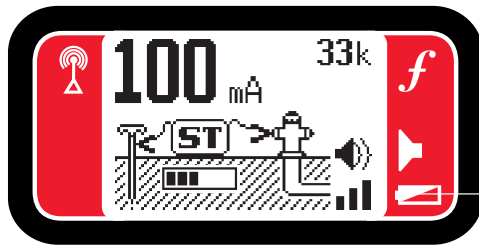

If the display screen shows “Lo,” the circuit is open or the unit is unable to draw adequate current for locating. Check your connections and improve the circuit to accurately locate.

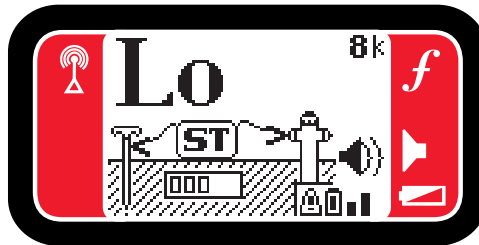

Inductive Clamp Mode

Read the Operator’s Manual for the Inductive Clamp before using it with the ST-33Q+. It includes important safety information and operating instructions.



Use the ST-33Q+ with an inductive clamp by following these steps:

1. Before connecting the inductive clamp, confirm that the target conductor is not live and that the ST-33Q+ is powered off. The ST-33Q+ is not designed to be connected to live conductors.
2. Insert the inductive clamp plug into the jack on the ST-33Q+ below the keypad.

- Place the jaws of the inductive clamp around the target conductor, ensuring that they close completely. The LEDs on the clamp are lit when the jaws are closed and the ST-33Q+ is powered on.



- Press the Power key . The ST-33Q+ automatically switches to Inductive Clamp Mode, disables the cable leads, and displays the word “Clamp” on the screen.

Note: In Inductive Clamp Mode, the ST-33Q+ defaults to 50 percent power level to conserve battery power.

- Select and set the same frequency on both the receiver and transmitter.
- Check the connections and adjust the current as needed during the locate.
- When finished, press the Power key to power off the ST-33Q+ before disconnecting the inductive clamp.

Inductive Mode

Disconnect the lead clips from any external conductors before switching the ST-33Q+ to Inductive Mode. If the lead clips are connected to an external conductor and the ST-33Q+ is switched to Inductive Mode, a warning appears and operator override is required.



Do not use clips and leads in Inductive Mode. The ST-33Q+ automatically sets the frequency to 33 kHz the first time Inductive Mode is used. After the first use, the ST-33Q+ will automatically use the frequency last used in Inductive Mode. The two frequencies available in Inductive Mode are 8 kHz and 33 kHz.

NOTICE Do not place two ST-33Q+s in Inductive Mode with the power on within 3 m [10 ft] of each other. The output of each ST-33Q+ can overload the electronics and damage one or both units.



Use the ST-33Q+ in Inductive Mode by following these steps:

- Place the ST-33Q+ so the red orientation arrows located on top of the ST-33Q+ are aligned with the target conductor.



2. Press the Power key  to power on the ST-33Q+. Press the Inductive Mode key  to toggle the ST-33Q+ between Direct Connect Mode and Inductive Mode.

Ground both ends of the utility for the best signal induction.

3. The ST-33Q+ defaults to 50 percent power level to conserve battery power while in Inductive Mode. If higher power is required for a clear signal, press the Up and Down Arrow keys   and select either 25 percent, 50 percent, or 100 percent.

When using an 18 V rechargeable battery or AC power the ST-33Q+ automatically switches to High Output Mode and a power of 200 percent is possible.

To power on and use the receiver, refer to the receiver's Operator Manual. Ensure the frequency on the receiver matches the ST-33Q+. If the receiver signal increases when held near the ST-33Q+, it is correctly picking up the transmitted frequency.

4. After completing the locate, press the Power key  to power off the ST-33Q+.



Self-Tuning Transmitter

In Inductive Mode, the ST-33Q+ self-tunes by modifying its own circuit to resonate at a frequency that matches the frequency selected by the operator.

In rare situations, if using Inductive Mode near a mass of metal, such as an automobile or transformer, the ST-33Q+ may not be able to tune to a desired frequency. The ST-33Q+ will attempt to tune to a desired frequency for up to 6 seconds. If it cannot tune to a desired frequency after 6 seconds, the ST-33Q+ suspends output, displays a warning, and emits a low beep.



If the ST-33Q+ cannot tune to a desired frequency try changing these settings:

- Press the Inductive Mode key  to return to Direct Connect Mode.
- Move the ST-33Q+ to a different location to perform the locate.
- Press the Frequency key  and select a different frequency to try in Inductive Mode.

Air-Coupling

Any transmitter in Inductive Mode generates a field through the air around it; including the ground underneath. If within air-coupling range of the ST-33Q+, the receiver will measure this field instead of the target conductor. Air-coupling will distort readings and misconstrue the location of the target conductor.

Air-coupling effects can dominate the received signal over a wide range (greater than 20 m [70 ft]) if the induced utility is deep and poorly grounded. Very weak induction and deep utilities will result in greater air-coupling distances. Always confirm the detection of utilities and the readings of depth measurements.

Air-coupling does not depend on the output power of the transmitter and cannot be reduced by turning down the power. Air-coupling only depends on the ratio of the field from the transmitter compared to the induced field in the target utility.

The effect of air-coupling can vary continuously so be aware of the difference between the transmitter's field and the induced field of the utility being traced. While both will have the same frequency, the transmitter's field is only strong enough to obscure the utility's signal in the region around the transmitter itself.

Be sure to look overhead for power lines that could also confuse the locate.

Testing for Air-Coupling

To test for air-coupling, tilt the locator at a 45 degree angle towards the ST-33Q+ and ensure the lower antenna of the receiver touches the ground. Afterwards, tilt the receiver 45 degrees away from the ST-33Q+ and observe the depth reading. If the depth reading changes significantly, air-coupling may be affecting the accuracy of the locate.

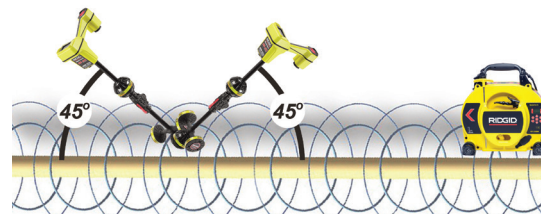

Alternatively, test for air-coupling by standing 6 m [20 ft] away from the ST-33Q+. With the lower antenna on the ground, take note of the indicated depth measurement on the receiver. Raise the receiver vertically 45 cm [18 in] and observe the change in the depth indication. If the receiver only reads the conductor, the depth should increase accordingly. If the receiver is air-coupling, the depth indication will not change by 45 cm [18 in], but will change disproportionately.

Using the Kick Stand in Inductive Mode

In Inductive Mode, the kick stand can be used to aim the output field and maximize the intersection with the conductor, while also reducing the field's intersection with a nearby known conductor.

Helpful Hints

- As a general guideline, using lower frequencies with the least amount of current and a clear signal will produce the best locating results. Start with a low frequency if tracing long distances or when receiving too much bleed-over onto other utilities.
- The ST-33Q+ will generate frequencies as low as 128 Hz in Direct Connect Mode. The ST-33Q+ will allow custom frequencies as low as 10 Hz.
- In general, 8 kHz offers a good starting point when using the ST-33Q+ in Direct Connect Mode. When using Inductive Mode, 33 kHz will likely be the best starting frequency.
- The ST-33Q+ will generate frequencies as high as 490 kHz (95 kHz in the European version). High frequency signals are especially valuable when tracing a line with interruption (such as a gasket or damaged insulation). Unlike low frequency signals, high frequency signals can “jump” some barriers and continue without appreciable dissipation.
- When using Inductive Clamp Mode, use higher frequencies since the signal must overcome additional resistance.

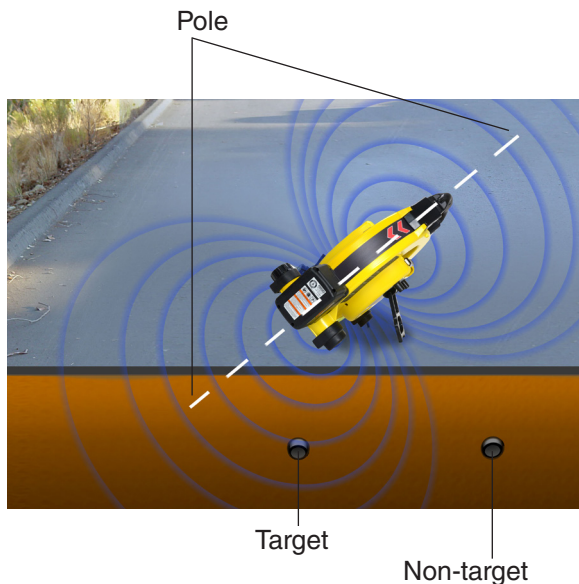



Customizing Settings

Access the Tools Menu  from the Main Menu to customize the following settings:

LCD Setting



In the Tools Menu select the LCD Setting option  **LCD** to adjust the brightness of the LCD screen. Press the Left and Right Arrow keys to adjust the brightness.

Audio Setting



In the Tools Menu highlight the Audio icon , and press the Select key  to toggle between on and off. Audio is on by default every time the ST-33Q+ is powered on.



Auto-shutdown Setting

The ST-33Q+ has an auto-shutdown feature that powers off the unit if a key is not pressed after a specified period of time.

In the Tools Menu highlight the Auto-shutdown icon  **1 Hr** to cycle through the auto-shutdown intervals. Press the Menu key  to save the selection and exit. During auto-shutdown, press any key on the keypad to restart the countdown.

Frequencies

Select the Frequencies option   from the Tools Menu to exclude default frequencies from the active frequency list. The ST-33Q+ lists active frequencies in the Main Menu for frequencies used most often and for frequencies that may require quick access.

Select frequencies within the Frequencies Menu to appear in the Main Menu list. Deselect frequencies in the Main Menu list to appear in the Frequencies Menu. Press the Up and Down Arrow keys   to highlight a frequency and press the Select key  to enable and disable it. The frequency in the list will have an arrow icon when enabled and an “x” when disabled.



Custom Frequencies

The ST-33Q+ can accept 40 custom frequencies for use in either Direct Connect Mode or Inductive Clamp Mode. Custom frequencies can be deselected within a mode without affecting the other mode.



The ST-33Q+ can accept custom frequencies from 10 Hz to 490 kHz for North America models and from 10 Hz to 95 kHz for European models. See the last page of this Operator's Manual for a list of frequencies used by common manufacturers.

Adding a Custom Frequency

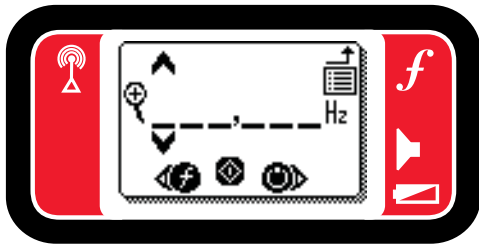

To add a custom frequency follow these steps:

1. Go to the Tools Menu.
2. Select Frequencies   and then Custom Frequencies  to display the Custom Frequency Screen.



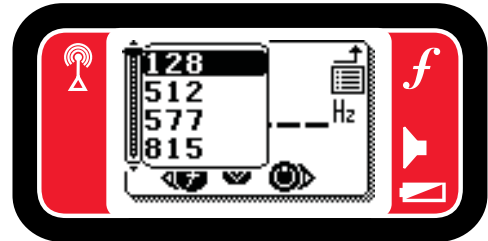

3. Move all the way to the left of the screen to access a drop-down list stored frequencies. Press the Up and Down Arrow keys   to move through the list. When highlighted, press the Select key  to input the frequency.



4. Press the Left and Right Arrow keys to move between each digit placeholder and the Up and Down Arrow keys   to increase and decrease the values. The ST-33Q+ adjusts the output frequency as each digit is entered. This auto-adjustment allows the tuning of the target frequency for maximum signal at the receiver. Press the Select key  to save and activate the frequency.



Editing a Custom Frequency

To edit a custom frequency, highlight it in the frequency list and press the Frequency key .

When the editing screen appears, press the Up and Down Arrow keys   to edit each digit. When a custom frequency has been edited, it will also appear as edited in the mode enabled.

Deleting a Custom Frequency

To delete a custom frequency, highlight it in the frequency list and press the Frequency key .

When the editing screen appears, press the Up and Down Arrow keys   to change each digit to zero. When each digit has been changed to zero, press the Select key  to delete the frequency from both the Direct Connect Mode and the Inductive Clamp Mode.

Odometer

Select the Odometer option  from the Tools Menu to make changes used for system diagnosis or to access operations data.

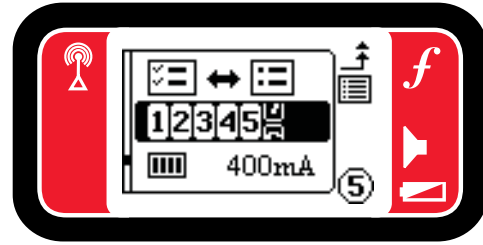





When selected, the Odometer option shows the number of hours each frequency has been used or the number of times each frequency has been selected for actual use. The Odometer option also displays the total time spent in each mode, minimum and maximum voltages encountered, and the amount of time spent at various power levels.



Press the Left and Right Arrow keys to toggle the Odometer between a list of system values and a list of frequencies showing the amount of time the ST-33Q+ has logged on each frequency and in various mode. Press the Menu key  to exit the Odometer option.



Reset to Factory Default

Note: Restoring the factory default settings will not erase user-defined frequencies or reset the Odometer stored values.

From the Information screen, press the Select key  to bring up the option to restore the ST-33Q+ to the default factory settings.

To reset the ST-33Q+ to the factory default settings, press the Up and Down Arrow keys   to highlight the Factory Reset option  and press the Select key .

To erase all custom frequencies, highlight the second option in the Factory Reset Menu  and press the Select key .

To exit the Factory Reset Screen without making changes, highlight the  icon and press the Select key  or press the Menu key .

Software

Software updates for the ST-33Q+ are released through HQ. You must register your ST-33Q+ in HQ's Equipment Locker to receive updates.

Software Support

For software support, please

- Visit www.hq.seesnake.com.
- Email hqsupport@seesnake.com.
- Call toll free 888-477-5339.

Updating ST-33Q+ Software

Register your ST-33Q+ in HQ's Equipment Locker to be automatically notified when software updates become available.

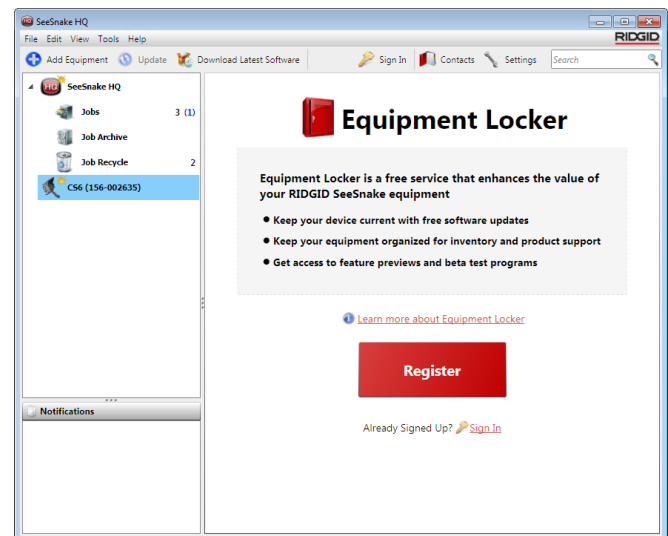

Note: A mini USB cord is required for updating the ST-33Q+.

1. Use a phillips head screwdriver to remove the front panel from the ST-33Q+ and access the mini USB port.



2. Use a mini USB cord to connect the ST-33Q+ to your computer. Power on the ST-33Q+ and open HQ.



3. Click on the ST-33Q+ icon in your Equipment Locker to check for an Update Available message.
4. If an update is available, click on Download Latest Software and follow HQ's instructions to proceed.

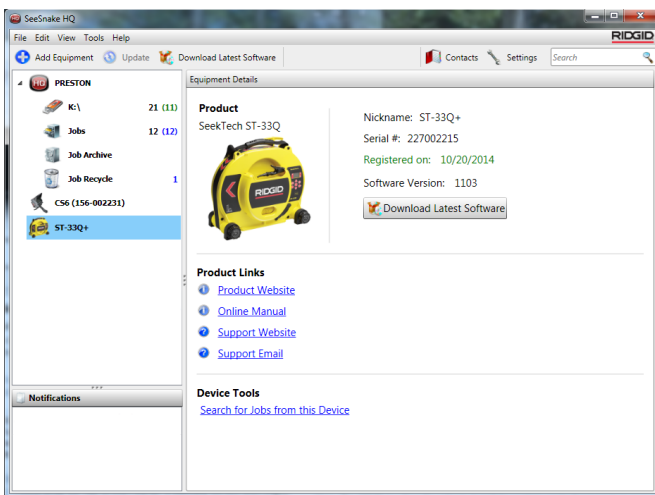

Maintenance

Cleaning

⚠ WARNING

Disconnect all cords and cables and remove batteries prior to cleaning the ST-33Q+ to reduce the risk of electrical shock.

Do not use liquid or abrasive cleaners on the ST-33Q+. Clean the ST-33Q+ with damp cloth. Only clean screen with cleaners approved for use on LCD screens. Do not allow any liquid to enter the ST-33Q+.

Accessories

⚠ WARNING

The following accessories have been designed for use with the ST-33Q+. Other accessories may become hazardous when used with the ST-33Q+. To reduce the risk of serious injury, only use accessories specifically designed and recommended for use with the ST-33Q+.

- RIDGID SeekTech SR-20
- RIDGID SeekTech SR-24
- RIDGID SeekTech SR-60
- SeekTech Inductive Clamp

Transport and Storage

Keep the equipment indoors or well-covered in wet weather. Store the ST-33Q+ in a locked area, out of the reach of children and people unfamiliar with its operation. This equipment could cause serious injury in the hands of untrained users. Do not expose to heavy shocks or impacts during transport.

Remove batteries before shipping and before storing for extended periods.

Store electrical devices in a dry place to reduce risk of electrical shock. Store in temperatures from -10°C – 70°C [14°F – 158°F]. Store the unit away from heat sources such as radiators, heat registers, stoves, and other products (including amplifiers) that produce heat.

Service and Repair

⚠ WARNING

Improper service or repair can cause the ST-33Q+ to be unsafe to operate.

Service and repair of the ST-33Q+ must be performed at a RIDGID Independent Authorized Service Center. To maintain the safety of the tool, make sure a qualified repair person services your equipment using only identical replacement parts. Discontinue using the ST-33Q+, remove the batteries, and contact service personnel under any of the following conditions:

- The equipment does not operate normally when operating instructions are followed.
- The equipment exhibits a distinct change in performance.
- The equipment has been dropped or damaged.
- Liquid has been spilled or objects have fallen into the equipment.

For information on your nearest RIDGID Independent Service Center or any service or repair questions:

- Contact your local RIDGID distributor.
- Go to www.RIDGID.com.
- Email the Ridge Tool Company Technical Service Department at rttechservices@emerson.com.
- Call 1-800-519-3456 (U.S. and Canada only).

Disposal



Parts of the unit contain valuable materials that can be recycled. There are companies that specialize in recycling that may be found locally. Dispose of the components in compliance with all applicable regulations. Contact your local waste management authority for more information.

For EC countries: Do not dispose of electrical equipment with household waste!

According to the European Guideline 2012/19/EU for Waste Electrical and Electronic Equipment and its implementation into national legislation, electrical equipment that is no longer usable must be collected separately and disposed of in an environmentally-correct manner.

Battery Disposal



RIDGID is licensed with the Call2Recycle® program, operated by the Rechargeable Battery Recycling Corporation (RBRC™). As a licensee, RIDGID pays the cost of recycling RIDGID rechargeable batteries.

In the U.S. and Canada, RIDGID and other battery suppliers use the Call2Recycle® program network of over 30,000 collection locations to collect and recycle rechargeable batteries. Return used batteries to a collection location for recycling. Call 800-822-8837 or visit www.call2recycle.org to find a collection location.

For EC countries: Defective or used battery packs/batteries must be recycled according to the guideline 2006/66/EC.

The ST-33Q+ is part of the Omni™ series of utility locating equipment.

Troubleshooting	
Problem	Solution
ST-33Q+ will not power on.	Check orientation of batteries.
	Check that batteries are charged.
	Check that the battery contacts are clean and unbent.
Receiver will not pick up the line transmitter's signal.	Check that the circuit is complete.
	Check that the transmitter is in the correct mode. See the descriptions for Direct Connect Mode, Inductive Mode, and Inductive Clamp Mode.
	Check that the receiver and the ST-33Q+ are set to the same frequency (for example, some receivers will use 93,622.9 Hz or 93,696 Hz instead of 93 kHz). Create custom frequencies to exactly match the receiver.
	Ensure the proper functions are activated on the receiver.
	Press the Up Arrow key to increase the power output.
	Ensure adequate grounding and improve if possible.
LCD screen completely dark or light when the ST-33Q+ is on.	Power the ST-33Q+ off and on.
	Check and adjust LCD brightness from the Tools Menu.
	If exposed to excessive heat or sunlight, allow the ST-33Q+ to cool.
ST-33Q+ appears stuck in one mode and will not reset.	Remove and replace or recharge batteries.
	Apply external power source.
ST-33Q+ cannot tune to a desired frequency.	Press the Select key to attempt to retune at the current frequency.
	Press the Inductive Mode key to return to Direct Connect Mode.
	Move the ST-33Q+ to a different location to perform the locate.
	Press the Frequency key and select a different frequency to try in Inductive Mode.

Appendix: Frequencies Used by Other Manufacturers

Frequencies Used by Other Manufacturers		
Company	Named Frequencies	Exact Measured Frequency
3M Dynatel	577 Hz	577 Hz
	8 kHz	8,192 Hz
	33 kHz	32,768 Hz
	200 kHz	200,000 Hz
Fisher Labs	820 Hz	821 Hz
	8.2 kHz	8,217 Hz
	82 kHz	82,488 Hz
Goldak	117.5 kHz	117,500 Hz
Health Consultants Incorporated	8.1 kHz	8,128 Hz
	81 kHz	81,326 Hz
	480 kHz	480,323 Hz
McLaughlin	9.5 kHz	9,499 Hz
	38 kHz	37,997 Hz
Metrotech	982 Hz	982 Hz
	9.8 kHz	9,820 Hz
	82 kHz	82,488 Hz
	83 kHz	83,080 Hz
PipeHorn	480 kHz	479,956 Hz
	512 Hz	512 Hz
	8 kHz	8,192 Hz
Radio Detection	33 kHz	32,768 Hz
	65 kHz	65,538 Hz
	82 kHz	81,865 Hz
	200 kHz	200,000 Hz
Rycom Instruments	815 Hz	815 Hz
	82 kHz	82,318 Hz
Schonstedt Instrument Company	575 Hz	575 Hz
SubSurface	8 kHz	8,055 Hz
	27 kHz	26,721 Hz
Subsite Electronics Ditch Witch	1 kHz	1,170 Hz
	8 kHz	8,009 Hz
	29 kHz	29,430 Hz
	30 kHz (150 R/T)	30,303 Hz
	80 kHz	80,429 Hz

WWW.RIDGID.COM

Ridge Tool Company
400 Clark Street
Elyria, Ohio 44035-6001
USA

1-800-474-3443

Ridge Tool Europe NV (RIDGID)
Ondernemerslaan 5428
3800 Sint-Truiden
Belgium

+32 (0)11 598 620

© 2020 Ridge Tool Company. All rights reserved.

Every effort has been made to ensure that the information in this manual is accurate. Ridge Tool Company and its affiliates reserve the right to change the specifications of the hardware, software, or both as described in this manual without notice. Visit www.RIDGID.com for current updates and supplemental information pertaining to this product. Due to product development, the photos and other presentations specified in this manual may differ from the actual product.

RIDGID and the RIDGID logo are trademarks of Ridge Tool Company, registered in the U.S. and other countries. All other registered and unregistered trademarks and logos mentioned herein are the property of their respective owners. Mention of third-party products is for informational purposes only and constitutes neither an endorsement nor a recommendation.

The Bluetooth word mark and logos are owned by the Bluetooth SIG, Inc.

Printed in USA

2020/02/05
748-031-0534-00-0A

RIDGID

EMERSON